

GO TRANSIT
TRACK WORKER SAFETY
INSTRUCTIONS

METROLINX RAILWAY
CORRIDORS

The instructions contained within this document are issued for the information and guidance of all employees and contractors engaged in the inspection, maintenance, and construction of track, roadway, signals, bridges, buildings and other structures and must be adhered to.

They apply to the operation of Metrolinx Railway Corridors operated by GO Transit and supersede CN General Engineering Instructions dated November 2013 and the TTR General Engineering Instructions dated 2011.

Except as provided herein, all Canadian Railway Operating Rules (CROR) and Special Instructions remain in force.

Office of GO Transit - Rail Corridors

August 11, 2016

TRACK WORKER SAFETY INSTRUCTIONS

METROLINX RAILWAY CORRIDORS

Table of Contents

1.0	General.....	1
2.0	Job Briefing.....	2
3.0	Personal Protective Equipment (PPE) and Clothing	3
	Forms of Protection	7
	Application of Portable Derails	7
	Derail Installation Instructions	8
4.0	Lone Worker Protection.....	9
5.0	Safety Watch	14
6.0	Separated Work Groups.....	15
7.0	Crossing Bridges Using Lone Worker or Safety Watch.....	16
8.0	Clearing Trains	16
9.0	Adjacent Track Instruction.....	17
10.0	Off Track Machinery	18
11.0	Track Unit Procedures.....	19
	Verifying Limits	21
	Working on or Around Track Units	24
12.0	Track Unit Operation	25
	Track Unit Operating Speed.....	26
13.0	Contractor Employee Qualifications	27
14.0	Handling Switches.....	32
15.0	Highway/Roadway Crossings and Traversing a Highway/Roadway Crossing	33
	Manual Protection at Highway/Roadway Grade Crossing.....	35
16.0	Scope	35
17.0	General Principles	35
18.0	Definitions.....	35
19.0	Protection Required.....	36
20.0	Equipment Required.....	40
21.0	Flagging Procedures	42

1.0 General

- 1.1 Every CROR qualified employee and/or Metrolinx designated contractor engaged in flagging services or: the inspection, maintenance, and construction of track, roadway, signals, bridges, and other rail corridors structures and infrastructure shall be subject to and conversant with these instructions. Except where specifically noted, the rules and regulations herein apply equally to employees and Metrolinx designated contractors and consultants. Going forward in this document the term employee will apply to all as per the CROR.
- 1.2 When local conditions necessitate, instructions in addition to those contained herein, may be issued providing further specific guidelines.
- 1.3 All employees are required to occupy, or foul any track, shall be governed by these instructions. They are also responsible to make themselves familiar with all conditions and special instructions applicable to the territory in which they are working.
- 1.4 Employees governed by these instructions must have a copy accessible while on duty. This includes an electronic copy.
- 1.5 An employee is foul of the tracks when:
 - the individual or equipment is within 4 feet (1.2 meters) of the nearest rail, or
 - over the yellow line at the edge of station platforms
- 1.6 Highway/Roadway Grade Crossing means a location where a public highway, road, street, or unrestricted private roadway and associated sidewalks and any pedestrian or bicycle pathway cross one or more railway tracks at grade.
- 1.7 Track unit means a vehicle or machine capable of on-track operation utilized for track inspection, track work and other railway activities when on track. (e.g. hi-rails, inspection vehicles, welding trucks, Brandt trucks, frog trucks, boom trucks, etc.).

2.0 Job Briefing

- 2.1 Prior to commencing any work, the employee in charge of a work group will hold a job briefing session for all persons engaged in the activity and visitors.

A supplemental job briefing is required when:

- Method of protection is changed, or
- Method of protection is extended or about to be released.
- Job task or conditions have changed.
- Work/travel activity did not begin within one (1) hour of the initial briefing.

- 2.2 The job briefing session shall cover all relevant issues with respect to the task being performed and necessary safety precautions that must be taken, including, but not limited to the following:

- Designation of the employee in charge.
- Method of on-track protection being used and the limits of authority.
- Track(s) that may be fouled or entered.
- Operational control of movements on adjacent tracks, if any.
- Procedure to arrange for protection on adjacent tracks, if necessary.
- An area for the name and signature of the Signal Maintainer assigned to crank power operated switches within USRC limits. The signature confirms agreement to the switches identified for routing by the approved written work plan between the Signal Maintainer and Protecting Foreman.
- Maximum zone speed and minimum sight line requirements when using safety watch protection, or if working adjacent to live tracks.
- Means of providing a warning when Safety Watch is used.
- Designated place of safety where workers will clear for trains or track units.
- Designated work zones around track units.

- Safe working and travelling distances between track units.
- All relevant emergency plan information.
- A documented field level risk assessment specific to the task to be performed must be completed and retained for 7 days for audit and incident investigation purposes.

2.3 At the conclusion of the job briefing, all employees and visitors shall confirm understanding. Job briefing information shall be kept in writing, on prescribed forms or job briefing books, for ready reference by each employee.

3.0 Personal Protective Equipment (PPE) and Clothing

3.1 Employees are required to wear CSA approved PPE appropriate to the work location and the job being done. The following PPE applies to all employees as a minimum requirement:

- Hard hats
- Protective eyewear
- Protective footwear (minimum 6 inches (152 mm) high, laced top, defined heel, Green patch)
- Reflective apparel (Approved for railway applications)

Exceptions to these requirements are as follows:

- When working inside designated office/buildings
- When inside an enclosed vehicle or equipment (car, truck, van, etc.)

3.2 Employees are required to wear hearing protection where posted or within 100 feet (31 meters) of operating machinery.

Personal Protective Equipment Charts

3.3 Table 1 contains craft-specific PPE charts for employees that outline requirements for protective equipment. The PPE chart is designed to work in conjunction with the requirements of Section 3.0.

TABLE 1: GENERAL PPE REQUIREMENTS

	Hearing Protection	Gloves	Rubber Gloves	Goggles	Face shield	Shin Guards	Respiratory Protection Contact Safety Department	Disposable Overalls	Rubberized Apron	Welder's Jacket or Sleeves	Welder's Leathers	Spats/Leggings	Welding Glasses (Shade #)*	Welding Helmet	Remarks/Special Requirements
Abrasive grinding (frog grinding portable)	R	R			R	R	X								
Abrasive grinding or cutting (stationary: bench grinder, chop saw, ect.)	R	X			R		X								
Adzing machine	R	R			R	R	X								Steel instep protection
Banding materials		R			✓										
Batteries: handling or servicing		R	X	R				X							Remove watch if not covered by gloves
Blowing/cleaning with compressed air, steam or water	R	R	X	R	X		X	X							
Boring, reaming, or drilling	R	X			X										
Boutet or thermite welding	R	R			R	R	X						6-8		
Breaking frozen material (ice, ground, gravel, cinders, ballast, etc.) with hand tools		R			R										
Breaking or cutting concrete, stone, or asphalt	R	R			R		X								
Buffing/polishing with wire wheel	R	X			R										
Cadwell bonding	R	R			R							R			
Carbon-arc cutting and gouging	R	R												R	
Chain saw, brush saw, and weed trimmers	R	R			R							R			Chain Saw & Brush Saw; legging/spats
Chemicals, refrigerants or fuels: handling		R	X				X	X	X						
Chipping or cutting	R	R		R											
Chop saw	R	R			R										
Cleaning agents: spraying/general use		X	X	X	X		X	X							
Climbing equipment		R													
Climbing poles and rail/work equipment		R													
Cut-off disks, saws, or other tools with carbide bits	R	R			R							X			

R= Required equipment

X= May be required based on task and materials

✓= Recommended additional equipment

TABLE 1: GENERAL PPE REQUIREMENTS (continued)

	Hearing Protection	Gloves	Rubber Gloves	Goggles	Face shield	Shin Guards	Respiratory Protection Contact Safety Department	Disposable Overalls	Rubberized Apron	Welder's Jacket or Sleeves	Welder's Leathers	Spats/Leggings	Welding Glasses (Shade #)*	Welding Helmet	Remarks/Special Requirements
Cutting rivets, bolts, or cotter keys; spitting nuts; etc. (mechanically)	R	R			R										
Cutting rivets, bolts, or cotter keys; spitting nuts; etc. (mechanically with torch)	R	R		R									6-8		
Dusty conditions							X	X							
Electrical hazard		X													
Electrical welding	R	R					X			✓	✓			R	
Gas welding, cutting, or heating	X	R					X			✓	✓		6-8		
Hammer-punch	R	R													
Hand tools	X	X													
Intermodal facility: outside of offices	R	X													
Lifting and carrying		X													
Machining steel, iron, or other metals	R	X			X										
MIG/TIG welding	R	R					X			✓	✓			R	
Mule: operation of car mover	R	R													
Painting/spray painting	X	X					X	X							
Pneumatic tools	R	R													
Powder-actuated tools	R	R		R											
Rail drill	R	R													
Rail grinder	R	R			R	R									
Rail saw	R	R			R								R		
Sand blasting (abrasive blasting)	R	R					R	X							Sand blast hood
Scaling, scraping, or removing welding flux	X	R			X		X								
Steam cleaning	R	R	R		R		X	X							
Striking or striking with hardened tools/fastenings	X	R													
Washing locomotives, machinery, or vehicles	R	R	X					X							
Woodworking machines	R	R			X										

R= Required equipment
X= May be required based on task and materials
✓= Recommended additional equipment

Forms of Protection

- 3.4 All employees required to foul* or occupy tracks must be protected by one of the following means:

- Positive protection as per the CROR (TOP, 841, 842)
- Safety Watch protection
- Lone worker protection

* Tracks may be crossed without positive protection only when sightlines permit.

If you must cross the tracks, look in both directions for approaching movements or track units. This precaution should be taken while approaching and crossing tracks. Walk straight across when safe to do so and not less than 25 feet (8 meters) from standing equipment that is not under your control.

Under Rule 842 protection, all personnel in separated work groups must stay clear of the track at all times after reporting clear.

Application of Portable Derails

- 3.5 In conjunction with CROR Rule 841, portable derails will be used where a special lock cannot be applied to a switch to prevent movement from operating over the portion of the track where work is being performed. The use of portable derails must be pre-approved by the Senior Manager Track & Structures as the only acceptable means of protection for that specific area and task.

Note: If pre-approval can't be obtained due to unforeseen circumstances the GO Transit Control Center (GTCC) and Senior Manager Track and Structures must be notified as soon as possible.

- 3.6 When any Rule 841 protection is applied or removed, the GO Transit Control Center (GTCC) must be notified and the use of red flags and special locks, or red flags and portable derails must be communicated and confirmed on the prescribed forms.
- 3.7 All portable derails must have a serial number and be controlled and accounted for by the user group at all times. Any loss or theft must be reported to the GTCC immediately.

- 3.8 Portable derails are to be installed 100 yards (91 meters) (if possible) on each side of the work location within the limits of the red flag. Portable derails are only to be used on tracks where speeds do not exceed 20 mph (32 km/hr).
- 3.9 Consider the following in selecting the orientation of the derail:
- Materials and Equipment – select the derail orientation (left hand or right hand) and place the derail such that a derailed car moves away from any stored material or equipment.
 - Adjacent Live Track – select the derail orientation (left hand or right hand) and place the derails such that a derailed car moves away from the adjacent live track.
 - Surrounding Terrain – select the derail orientation (left hand or right hand) and place the derails such that a derailed car moves away from any waterways, highways, roadways, non-Metrolinx lands and/or sensitive/restricted areas.

Derail Installation Instructions

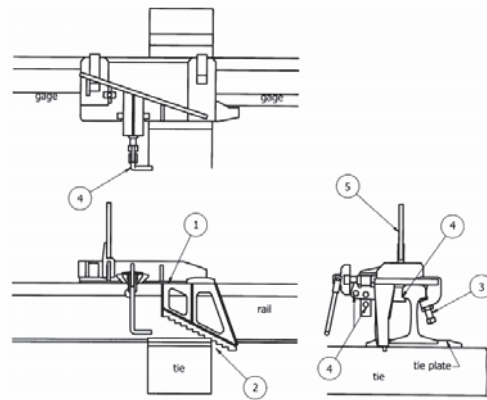

- 3.10 Loosen set screws, and screw handle, place derail on top of rail, make sure the derail is level, and parallel to the gage line of the rail.
- 3.11 The graduated teeth must be against the corner of the tie or tie plate, on the gage side of the rail. remove ballast as needed. Do not install derail on the inside rail of a curve.
- 3.12 Adjust set screws on the field side of the derail to a light bearing under the rail head, tighten jam nuts.

- 3.13 Hand tighten screw handle to secure derail to railhead. Align holes for applying padlock.
- 3.14 Position the derail warning flag.

4.0 Lone Worker Protection

In absence of adequate sightline distances positive protection must be used for any class of track.

- 4.1 Employees using lone worker protection must participate in a job briefing with his or her supervisor or other designated employee. The job briefing must include the lone worker's planned itinerary and the duration the task will take.
- 4.2 Employees performing the tasks shown in Table 2 using lone worker protection will comply with the following:
 - The work must not affect the movement of trains;
 - The lone worker must be able to visually detect the approach of a train at maximum timetable speed and be in a place of safety 15 seconds before the arrival of the train;
 - Power operated tools and track units are not in use within hearing distance;
 - The ability to hear and see approaching trains and track units is not impaired by background noise, lights, precipitation, fog, passing trains or physical conditions;
 - The employee has identified a place of safety prior to occupying or fouling the track.
- 4.3 An employee who uses lone worker protection must first complete the Statement of On-Track Safety. The statement must designate the date and time for which it is valid. The statement must also indicate the maximum authorized speed of trains within the limits and the sight distance that provides the required warning of approaching trains. The lone worker using lone worker protection to establish protection shall produce the Statement of On-Track Safety when requested by a company officer.
- 4.4 A lone worker must use another form of protection if:

- The requirements of 4.2 cannot be met, or
- The task to be undertaken is not listed in Table 2.

Determination of Adequate Clear Sightline Distance for Lone Worker and Safety Watch

- 4.5 There are a number of ways in which clear sightline distances can be determined. In the absence of site specific job aids/safety procedures employees should select the method that best suits their situation.
1. Track features such as crossings, bridges, overpasses, turnouts, way side buildings, etc., whose mileage is known can be used as reference points to determine the sight distance from the work location.
 2. Mileage boards can be used as a reference point to determine the sight distance from the work location.
 3. If railway pole lines are present, these can be counted in either direction to obtain sightline distances.
 4. If a work location is one that is frequented often (such as a turnout, road crossing, railway crossing at grade, etc.), a tape measure, measuring wheel or a track unit with a distance counter can be used to measure sight distances for all future visits to that location.
 5. The use of portable hand held optical distance measuring devices may be used to determine clear sightline distances.

NOTE: Employees may be required to demonstrate how the sightline distance was obtained. This information must be recorded in the job briefing book.

- 4.6 Lone Worker Protection will NOT be considered as adequate protection where sightlines, train speeds, weather conditions, restricted clearing ability, etc., do not allow sufficient time for the employee being protected to move to and occupy a previously arranged place of safety not less than 15 seconds before a train moving at a maximum speed for that track, reaches that point. Should more time be required to clear the track, it must be added to the 15 seconds.

Example: An employee is working

under Lone Worker protection on a track where the maximum train speed is 35 mph (56 km/hr). It is determined that it will take the employee 5 seconds to clear himself and his tools from the track and be in a place of safety after being warned of an approaching train. The 5 seconds must be added to the 15 seconds indicated above. Therefore, from the table below, the clear sight lines required are found under the 20 second column for a train speed of 35 mph (56 km/hr), or 1030 feet (314 meters) of clear distance in either direction.

- 4.7 Table 3 indicates the required distance by which time employees and their tools must be completely in the clear and in a safe location for trains traveling at various speeds.

TABLE 2: WORK PERMITTED UNDER LONE WORKER OR SAFETY WATCH PROTECTION

	Description of Work	Permitted Under Lone Worker	Permitted Under Safety Watch
1	Anchoring	yes	yes
2	Bolt tightening or individual replacement	yes	yes
3	Bonding – without drilling	no	yes
4	Bonding – temporary or replacing plug bond	yes	yes
5	Brush cutting – Foul of track hand tools only	yes	yes
6	Brush cutting – Underneath bridge	yes	yes
7	Cotter key replacement	yes	yes
8	Crossing testing	yes	yes
9	Culvert inspections	yes	yes
10	Derail adjustment	yes	yes
11	Digging/shoveling ballast by hand	yes	yes
12	Drifting joints	no	yes
13	Gauge rod removal/installation	no	yes
14	Grinding	no	yes
15	Hand measuring of clearances	yes	yes
16	Inspection of bridges from underneath or beside bridge	yes	yes
17	Inspection of signal apparatus and appliances	yes	yes
18	Inspection of track - on foot	yes	yes
19	Lagging screws - off track tools only	no	yes
20	Lubricating	yes	yes
21	Painting comp joints, switch handles, derails, safety appliances, etc.	yes	yes
22	Pole line work	yes	yes
23	Rail wear/ Track geometry measurements	yes	yes
24	Snow clearing device (SCD) installation, removal and maintenance.	no	yes
25	Shoulder trimming with hand tools	yes	yes
26	Shunting- must have permission from RTC	yes	yes
27	Sign repair and installation-	yes	yes
28	Signal alignment	yes	yes
29	Signal and utility locates	yes	yes
30	Slotting joints	no	yes
31	Snow removal – hand tools only	yes	yes
32	Snow removal – with compressors and backpack blowers** (Not applicable on main track or where speeds are greater than 15 mph)	no	yes
33	Spiking/clip installation	yes	yes
34	Semi automatic spring switch testing (Only applicable on yard tracks where track speed is 15 mph or less)	no	yes
35	Surveying/layout/staking/alignment measurements	yes	yes
36	Switch target replacement/maintenance	yes	yes
37	Tamping by hand (without track jacks)	yes	yes
38	Tie plate replacement (single tie plate without jacks)	yes	yes
39	Tie marking/painting defective ties	yes	yes
40	Welding, points, frogs, and joints	no	yes

- 1) **When hand tools specified no power tools are permitted.**
 2) ****In the application of Item 32 the following conditions apply**
 a. **applicable where track speed is 15 mph or less**
 b. **Not applicable on main tracks.**

**TABLE 3: MINIMUM REQUIRED SIGHTLINE
DISTANCES**

Train Speed (mph)	Required Sight Lines (in feet)			
	15 seconds	20 seconds	25 seconds	30 Seconds
10	220	295	370	440
15	330	440	550	660
20	440	590	735	880
25	550	735	920	1100
30	660	880	1100	1320
35	770	1030	1290	1540
40	880	1175	1470	1760
45	990	1320	1655	1980
50	1100	1470	1840	2200
55	1210	1615	2020	2420
60	1320	1760	2205	2640
65	1430	1910	2390	2860
70	1540	2055	2570	3080
75	1650	2200	2755	3300
80	1760	2350	2940	3520
85	1870	2495	3125	3740
90	1980	2640	3310	3960
95	2090	2790	3490	4180
100	2200	2935	3675	4400

5.0 Safety Watch

- 5.1 Work that is performed on or about the track that does not require positive protection as provided by the Canadian Rail Operating Rules (CROR) may be performed using Safety Watch protection.

In absence of adequate sightline distances positive protection must be used for any class of track.

A list of work that can be undertaken under Safety Watch is provided in Table 2.

Duties of Safety Watch

- 5.2 The sole duty of the Safety Watch is to protect working personnel by continuously monitoring all approaches to the work site for train and track unit movements or other hazards. The Safety Watch must dedicate their entire attention to this task and never engage in distracting activities, such as talking on a cell phone, text messaging, browsing, etc. In addition, they are never to engage in any other distracting activities, including the work being undertaken.

Safety Watch Job Briefing

- 5.3 Prior to implementing Safety Watch protection, the employee in charge, the Safety Watch and the employee(s) being protected must conduct a thorough job briefing to ensure that at a minimum the following items are covered and there is a clear understanding of:
- Identification of track or tracks to be fouled;
 - The date work is performed;
 - Who is the designated Safety Watch;
 - Where the Safety Watch will be positioned;
 - What work is to be performed;
 - If additional clearing time is required;
 - The maximum speed of trains on that track and required sightline distance;
 - The sightline distance at the work site;

- Where the workers will clear on the approach of rail traffic;
- How the warning is to be given;
 - Can be voice communication, direct touch, use of an air horn or marine emergency whistle.
 - Consideration must be given to the number of workers being protected and how spread out they are.
- Where any tools are to be placed when clearing;
- Who will clear the tools;
- Other risks at the work site.

This information must be documented (in writing) in the job briefing notes.

6.0 Separated Work Groups

- 6.1 When the nature of the work or size of the work crew and the length of the work limits are such that the Foreman named in the track authority protection (Protecting Foreman) cannot personally observe, and supervise all persons engaged in the work, directly related to the protecting foreman's work project, he/she shall assign a sub-foreman in charge of the separated work group as per CROR Rule 855 special instructions, "Procedures for the Protection of Sub-Foreman Work Groups".
- See section 8.0 Clearing Trains for additional Metrolinx Special Instructions.
- 6.2 In the interest of work block coordination, every effort must be made to coordinate activities under a single Rule 842 where and when possible. This would allow pre-authorized work to be conducted under sub-foreman protection. This does not alleviate the restriction limit of 4 sub-foremen under a protecting foreman on Metrolinx owned multi-track corridors.
- 6.3 When authorized through a Rail Corridors risk assessment, outside of multi-track territory, up to eight (8) separated work groups may be allowed. See 1.2.
- 6.4 The protecting foreman and all sub-foremen shall write down the time a

train is cleared through the work limits, or has passed the protecting foreman's and the sub-foreman's location on their clearing sheets in all cases.

7.0 Crossing Bridges Using Lone Worker or Safety Watch

- 7.1 Employees who need to cross bridges in the performance of their duties using either Lone Worker or Safety Watch protection may do so provided that: sightlines are adequate to ensure they can safely exit the bridge, and they will be in a position of safety 15 seconds before the arrival of the train.
- 7.2 Refuge bays on bridges can only be used for clearing trains during walking bridge inspections.

8.0 Clearing Trains

- 8.1 Where track protection authority permits, a train may be authorized by the Protecting Foreman to enter the protection limits and proceed to a location within the limits short of the working point. This location must be a clearly identifiable point such as a mile board, point of switch, public crossing, bridge, etc. and must be identified by mileage. The Protecting Foreman must not permit the train to proceed further until he/she has confirmed that all of the procedures with respect to authorizing trains through protection limits have been met.

NOTE 1: In the application of section 6.0 Separated Work Groups:

- The foreman must clear all sub-foremen up to the defined restriction point as per 8.1 above before authorizing a train to enter. The foreman must then clear all sub-foreman for the remainder of his limits before authorizing the train to proceed from that defined restriction point.
- The foreman or sub-foreman must apply section 6.4 before authorizing work to resume.

NOTE 2: Within the USRC this is only applicable where CROR Rule 842 protection is in place.

- 8.2 Except in the case of emergency, a train or engine authorized into the protection limits may only be stopped

once for the purpose of clearing employees.

- 8.3 Except as determined through risk assessment and approved in written safe work plans, trains shall not be instructed to blow the whistle while passing men and equipment. Note: Transport Canada crew instructions and urban noise disturbance considerations must be evaluated.
- 8.4 Workers required to clear for a train must position themselves in a safe location. Under no circumstances may employees stand on live and unprotected track while observing passing trains on adjacent tracks. Where the work area includes difficult terrain or special features such as bridges or tunnels, a safe clearing area must be identified prior to occupying or fouling the track.
- 8.5 On the approach of a movement, employees are to face the oncoming movement and the foreman or designate must acknowledge the movement by a raised hand signal.
- 8.6 In single track territory when track units are removed from the track or cleared in a nearby spur, siding or back track, booms, wings, etc. must be retracted and secured clear of the affected track. Small tools and other material must also be cleared and secured to avoid being struck by a passing train.

9.0 Adjacent Track Instruction

- 9.1 In the application of this instruction, adjacent tracks that are governed by CROR Rule 105 and that are fouled will require protection.
- 9.2 In multi-track territory, positive track protection must include the track or tracks immediately adjacent to the track on which the work is being performed. Tracks shall be considered adjacent when the measured distance between track centers is less than 25 feet (7.6 meters). In the USRC adjacent track protection will be determined through hazard assessment and documented in the work planning and approval stage.
- 9.3 Exception: In multi-track territory, where the Protecting Foreman is in immediate contact by radio or in-person with all track units and workers,

and the track units being protected and the activity being performed will not foul an adjacent track as per instruction 1.5, track protection need not be applied on adjacent tracks. When clearing trains in multi-track territory, workers must avoid crossing over live unprotected track. Only those employees instructed by the Protecting Foreman may cross a live track for the purposes of providing a train inspection. When working on an inside track that is bound by live tracks, workers must position themselves between the rails of the protected track on which they are working when clearing a train.

10.0 Off Track Machinery

- 10.1 Off track machinery such as bulldozers, frontend loaders, excavators, etc. which are working within 13 feet (4 meters) of the nearest live rail or such that boom swing or bucket extension will extend within 13 feet (4 meters) of the nearest live rail, must be provided with positive protection in accordance with applicable operating rules.
- 10.2 Off track machinery working within 30 feet (10 meters) of the nearest live rail, regardless of protection, must stop working on the approach of a train and remain stopped until the train has passed.
- 10.3 Off track machinery working between 13 feet and 30 feet of the nearest live rail requires protection by a flag person.
- 10.4 Temporary Concrete Barriers (TCBs) may be used to separate off track equipment and workers from live tracks when approved by Rail Corridors through a joint risk assessment and supported by documented site safety procedures.

The TCBs must be:

- Placed no closer than 2.1 m (7 feet) from the nearest live rail
- Placed no closer than 150 meters (500 feet) to any road crossing at grade
- Fitted with removable fencing on top of each section
- Kept clear of controlled switch and signal locations in order to allow

access for inspections and maintenance

- Kept to running lengths of less than 2 kilometers
- Inspected on a daily basis to ensure that no TCB sections have been pushed into the clearance envelope
- Communicated to the GO Transit Control Center (GTCC) 24 hours prior to installation and immediately upon removal

When TCBs are being considered, items 10.1 through 10.3 must be accounted for in the risk assessment and the site specific safety procedures. Works on the other side of the barrier cannot impact the barrier, or go through and/or over the barrier and interfere with trains.

The use of TCBs does not eliminate the need for Job Briefings and situational awareness. The flag person has the authority to stop unsafe activity posing an immediate threat to people or train operations.

- 10.5 Off track equipment working under positive protection must not travel on the ballast shoulder of the track. If no other option exists, and authority is granted by Rail Corridors, the ballast must be inspected and restored to standard prior to release for train service with no speed restrictions.

FIGURE 1: TYPE OF PROTECTION NEEDED

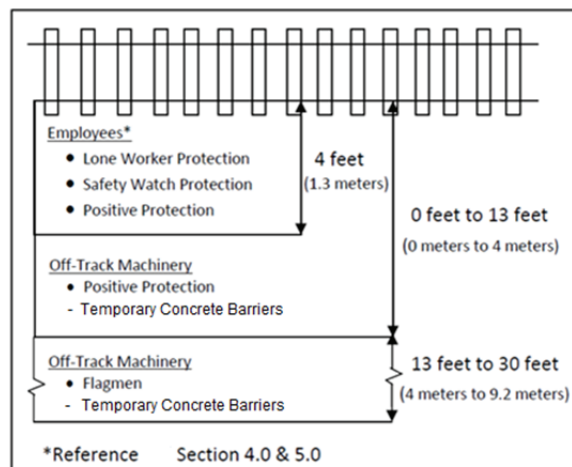

11.0 Track Unit Procedures

- 11.1 Operators of track units, while on rail, must be qualified in the GO Track Worker Safety Instructions and Metrolinx approved Canadian Rail Operating Rules (CROR), must be

knowledgeable of the physical characteristics of the unit in which they are operating and must become familiar with and be governed by the operating and maintenance instructions or manuals supplied by the Railway and/or Manufacturer. Operators of hi-rail vehicles must have a valid motor vehicle license appropriate for the class of the vehicle, including air brake endorsement as required, plus training in Safe Hi-Rail Operation.

- 11.2 Pre-trip inspection of track units is required at the start of every shift.
- 11.3 The operator of a track unit is responsible for completing the required logbook(s), and to inspect and to maintain the track unit at the prescribed frequency.
- 11.4 Unauthorized persons are not permitted to ride on track units. With the exception of Federal, Provincial or Municipal police and Federal Regulatory Officers (with valid identification and in the course of duty), all authorized, non-Company personnel are required to sign a "Release of Liability" form when riding on track units.
- 11.5 Unless specified, track units must not be relied upon to shunt track circuits

Track units with damaged or defective insulation must be repaired immediately.
- 11.6 When a track unit operator or pilot is copying a track authority, writing other information, or using ETOP, the track unit must be stopped.
- 11.7 When a train is operating on an adjacent track, track units must be brought to a stop. If it can be done safely, the passing train should be inspected on both sides.

Note: This instruction does not apply within the USRC limits.
- 11.8 In the application of CROR 857 special instruction, the following will apply:
 - Prior to entering the limits of the confliction(s) as indicated on the foreman's TOP the foreman named in the authority must contact all other conflicting foreman. If unable to contact the conflicting foreman named in the

authority, the foreman named in the authority may enter the said limit but only to the point to cancel the preceding TOP, or clear the main track. The foreman may only clear the track after trying to communicate with the conflicting foreman by all means and through the RTC. When clearing, the foreman must:

1. Be able to visually see the next crossing or siding switch, and
2. Not exceed 10 mph (16 km/hr).

11.9 All occupants riding in a track unit are responsible for its safe operation.

11.10 Verifying Limits

- a) Operators of track units being protected must have in their possession, written or electronic confirmation of their authority to occupy the track and the working limits. When working in a group consist (two or more track units), only the lead track unit and the rear track unit are required to have in their possession a written or electronic copy of the protection or authority.
- b) When working or traveling, the lead track unit must comply with the following requirements:

Prior to passing a controlled signal or identifiable location, the occupants of the track unit must:

- i. Review the permit or authority to verify the controlled location or identifiable point being approached is included in the current protection.
- ii. For the purpose of this instruction identifiable locations are station name signs, siding switches, and/or mileage posts.
- iii. When switches within the USRC are used as identifiable locations, approved Fouling Point Markers must be put in place to indicate the limits of protection. Fouling Point Markers shall be equipped with lights for night time visibility.



Fouling Point Marker

- c) When travelling within the same controlled signals or identifiable location multiple times (working), the occupants are required to verify they are authorized to enter the limits upon the initial entry only. They may work within the location moving in both directions an unlimited number of times; however the permit/authority need only be verified once.
 - d) The rear track unit need not stop at control points or identifiable locations unless it reverses direction and becomes the lead unit.
 - e) The instructions of this section (Section 11.10) do not apply to test cars within the working limits when testing.
- 11.11 When a superseding TOP is to be issued to a foreman that includes limits the foreman is currently occupying, the superseding TOP must include that section of track. The foreman must advise the RTC of his/her exact location prior to copying the superseding TOP. In addition, the foreman must ensure that all employees, sub-foremen and track units are within the new limits to be granted prior to repeating the superseding TOP to the RTC.
- 11.12 The operator must ensure that the track unit is equipped with a proper railway flagging kit, first aid kit, charged fire extinguisher and a train radio. A communication plan must be established and approved within the USRC as the Train Movement Directors (TMDs) operate on UHF radio frequencies.
- 11.13 All employees required to flag a road crossing must also have approved traffic control paddles or signs in their hi-rail or highway trucks at all times and must be qualified as per sections 15-21 of these instructions.
- 11.14 Cell phones are not to be used in track units unless they are connected in hands

free operation, or the track unit has been brought to a stop before use. Personal cell phones are not to be used during working hours.

- 11.15 All tools and materials must be properly secured against movement when the track unit is operating.
- 11.16 Track units may be coupled only by using an approved coupling device.
- 11.17 Lights to the front and rear and strobe lights, (when available), must be displayed when the track unit is operating on rail. (Note: Strobe lights must not be operated when traveling on the highway.)
- 11.18 When it is necessary for individual employees to travel under difficult conditions such as extreme heat or cold, heavy snow or rain, or in remote areas, etc. additional safety precautions such as establishing specific call-back times with another competent employee, shall be taken.
- 11.19 Unless protected by CROR Rule 105c, when not in immediate use or left unattended, track units must be protected against trains or engines and secured against unauthorized or unintentional movement. Track units may be protected by CROR 841 or other methods, i.e. removing the track from service.
- 11.20 Track units must not be left unattended unless the doors are locked and keys removed, or the batteries are isolated and locked out. The hi-rail equipment shall be disabled or portable derails and/or chains shall be put in place to prevent accidental movement. All carts must be chained to the track to prevent them from being moved by unauthorized persons.
- 11.21 Track units must not be brought to a stop on the switch points of dual control switch or the point of a moveable point frog.
- 11.22 Semi-automatic switches must be lined by hand for trailing point movements by track units.
- 11.23 Track units must operate over self-restoring dual control switches and power operated self-restoring derails in accordance with instructions, if issued, for those devices otherwise they must be

placed in hand position when being traversed by a track unit.

- 11.24 Except during the actual working operation, extendible working components of a track unit must be retracted to the travel position and all locking devices put in place before the track unit is moved.
- 11.25 Track inspections and track work should be planned such that track units operate or work in the forward direction whenever possible. When necessary to change direction of travel, if possible and practicable, track units should be turned and operated in the forward direction.
- 11.26 The following safety precautions must be taken when operating track units in reverse:
- Lights on the leading end of the track unit must be illuminated.
 - A back up audible alarm must be operating. If not so equipped or operable, the operator must sound the horn on a regular basis. Three short sounds of the horn will be used before commencing a reverse movement.
 - When visibility in the reverse direction is obscured, another employee must be positioned so as to warn the operator of any obstructions.
 - Employees operating track units designed to work in both directions and working within a gang consist must conduct a job briefing session ensuring that procedures involving the track unit(s) movements and the operation of the gang are covered.

Working on or Around Track Units

- 11.27 The following precautions must be taken when working on or about track units:
- All persons operating or riding in track units must understand the duties that each person will perform.
 - Use handrail if so equipped, when getting on, getting off or riding a track unit.
 - A track unit must be stopped before getting on or off. Exception: Authorized personnel may entrain or detrain a tamper in work mode.
 - Use the 3-point contact method when getting on or off a track unit.

- When working near or observing track units, communicate with the operator and ensure that the following is understood:
 - Operating procedure,
 - Location of employees working around and observing the track unit,
 - Operators blind spot,
 - Signal warnings that track unit will move,
 - Where duties require employees to be near working track unit, employees must stay outside the 15 foot (4.5m) safe area,
 - Where duties require the employees to be within the 15 foot (4.5m) safe area, the operator and employee must jointly establish a safe location for the employee to occupy.

12.0 Track Unit Operation

- 12.1 Track units will operate under full control prepared to stop at all times. Operators must be increasingly vigilant as they approach any level crossing (public, private, farm or pedestrian), interlocking, animals or people near the track and when passing over bridges.
- 12.2 Initial brake test – Immediately after setting the unit in motion the brakes must be tested to ensure they are operating properly. In all cases, occupants, if any, are to be warned of brake tests by the operator.
- 12.3 Distance to stop test – The operator must conduct a “distance to stop” test when the track unit reaches the operating speed. This will be done by applying full controlled braking without producing a wheel skid situation while bringing the vehicle to a complete stop. Further “distance to stop” tests must be conducted when there are changes in conditions that affect the track unit’s ability to stop, in advance of areas with poor sight lines, road crossings or other work groups.
- 12.4 Immediately after performing a “distance to stop test” and while still stopped, the following information must be recorded:
 - Time the test was performed,

- Location where the test was performed,
- Operating speed at the start of the test,
- Braking distance.
- Rail condition. (dry, wet, snow, etc.)

The recorded information must be retained and available for inspection for the duration of the shift.

- 12.5 Track units must maintain a spacing of at least 300 feet (91 meters) between track units, when traveling. Track units must maintain a spacing of at least 500 feet (152m) from a standing train or engine on the same track, or when following a moving train or engine. These distances may be decreased if there is a clear understanding with the train or engine that it is safe to do so. An increase in spacing is required if stopping distances are increased.
- 12.6 When track units are traveling together, track unit operators must advise each other when planning to stop. If communication with the other track unit operator(s) is not acknowledged, the operator must stop the track unit, exit and use all possible means to flag the following track unit operators to stop.
- 12.7 While working, track units must maintain a minimum 40 feet (13m) spacing between units. If work requires a closer spacing, clear communication and understanding between all operators and employees must be established and maintained at all times.

Track Unit Operating Speed

- 12.8 Track units will operate at a speed not exceeding "Track Unit Speed", unless otherwise directed by Operating Rule or Special Instruction.
- 12.9 Track units unless specified by special instruction for a particular unit or type of unit must not exceed a maximum of 25 mph (40 km/hr).
- 12.10 Track units must not exceed 5 mph (8 km/hr.) over any switch that has power operation capability, or moveable point frogs.
- 12.11 Track units will operate with extreme caution while traveling through the closed point of a spring frog, self-

guarded manganese frogs and all other special track work, ensuring that all wheels are properly on the rails at all times.

- 12.12 Unless otherwise specified by special instruction, the maximum speed, when reversing, will be Track Unit Speed not exceeding 15 mph (25 km/hr).

13.0 Contractor Employee Qualifications

Contractors working for Metrolinx must comply with the requirements below. Exemptions may only be granted by the Sr. Manager Track & Structures, Rail Corridors or his/her representative in the case of emergencies.

Contractor Requirements

- 13.1 The contractor must identify a Safety Officer who will be a point of contact for Metrolinx on:
- Safety related matters such as action plans and audit reports
 - Employee qualifications
 - Employee training
 - Exchanging documentation on policy and procedure changes, etc.
- 13.2 Provide Metrolinx with a list of the CROR Qualified employees working on or expecting to work on Metrolinx property and their qualifications. This includes the employee's full name, date of birth as well as:
- Training completion dates
 - Refresher and recertification due dates
 - Proof of training provider and course content. (i.e. CTC, Interlocking rules, track work and track unit rules, special instructions etc.)
 - Metrolinx will only accept CROR qualifications that are provided by Metrolinx approved training consultants.
- 13.3 Employees must carry documented proof of training in their possession while on Metrolinx property. Employees who are not in the list per rule 13.2 and who's proof of qualifications are not provided will not be allowed on Metrolinx property.
- 13.4 Contractors must ensure that their employees are briefed and are

provided current copies of Metrolinx's standards and policies including most recent updates.

13.5 In order to allow new employees access to a Metrolinx work site, the following process must be followed:

- Contractors must provide their names and qualifications to the office of the designated Metrolinx Project Manager prior to these employees gaining access to Metrolinx property.
- Contractor must receive Metrolinx's acceptance of the qualifications prior to new employees entering Metrolinx property.

13.6 Provide a safety plan to Metrolinx including the following but not limited to:

- An injury prevention program
- Safe track unit operation
- Staying within their track authority limits
- Specify method of ensuring compliance and an auditing process
- Field level risk assessment

Metrolinx Requirements

13.7 Metrolinx will provide the track protection for contractors, except in specific cases as authorized by Metrolinx.

13.8 Metrolinx will specify the level of training required in the following tables.

JOB SPECIFIC TRAINING REQUIREMENTS

NOTE: The job specific training requirements of Table 5, 6, and 7 do not preclude other training requirements specific to the position: such as crane, welder, machine operation or other trade skills as the job may require.

TABLE 5: TRACK TRAINING REQUIREMENTS

Job Title / Role	GO-SAFE Railway Orientation	CROR	TWSIs	Track Inspection Guidelines	Track Unit Operations
Foreman / Asst Foreman	Yes	Yes	Yes	Yes	Yes
Machine Operator – On Track	Yes	Yes	Yes	n/a	Yes
Machine Operator – Tamper	Yes	Yes	Yes	Yes	Yes
Machine Operator – Off Track	Yes	n/a	n/a	n/a	n/a
Flagman	Yes	Yes	Yes	Yes	Yes
Flagman – other*	Yes	Yes	Yes	n/a	n/a
Trackman / Welder / Labourer	Yes	n/a	Yes	n/a	n/a

* Note: This has limited application. It includes protecting utility companies and work not impacting track infrastructure.

TABLE 6: BRIDGE TRAINING REQUIREMENTS

Job Title / Role	GO-SAFE Railway Orientation	CROR	TWSIs	Track Inspection Guidelines	Track Unit Operations	Fall Protection	Fall Rescue	Confined Space
Bridgetenders	Yes	Yes	Yes	n/a	n/a	n/a	n/a	n/a
Machine Operator On Track	Yes	Yes	Yes	n/a	Yes	As required	As required	n/a
Machine Operator Off Track	Yes	n/a	n/a	n/a	n/a	n/a	n/a	n/a
Workers On Bridges	Yes	n/a	n/a	n/a	n/a	Yes	Yes	n/a
Workers Off Bridges	Yes	n/a	n/a	n/a	n/a	n/a	n/a	n/a
Flagman	Yes	Yes	Yes	Yes	Yes	n/a	n/a	n/a
Culvert Work/Inspection	Yes	n/a	n/a	n/a	n/a	n/a	n/a	As required

TABLE 7: S&C TRAINING REQUIREMENTS

Job Title/Role	GO-Safe Railway Orientation	CROR	TWSIs	Boom Truck Qualifications	Track Unit Operations	Fall Protection	Signal Apprenticeship Qualifications
Foremen / Coordinator	Yes	Yes – Note 1	Yes	n/a	Yes – Note 1	Yes	n/a
Ground Work only							
Foremen/Coordinator	Yes	Yes – Note 1	Yes	n/a	Yes – Note 1	Yes	Yes
Ground work, Wiring and Hookup							
Machine Operator – on Track	Yes	Yes	Yes	n/a	Yes	Yes – Note 3	n/a
Machine Operator – off Track	Yes	n/a	Yes	n/a	N/A	Yes – Note 3	n/a
Flagman	Yes	Yes	Yes	n/a	Yes	n/a	n/a
Boom Truck Operator- on Track	Yes	Yes	Yes	Yes	Yes	Yes – Note 3	n/a
Boom Truck Operator- off Track	Yes	N/A	Yes	Yes	N/A	Yes – Note 3	n/a
Mechanic/ Maintainer	Yes	Yes – Note 2	Yes	n/a	Yes – Note 2	Yes	Yes
Laborer	Yes	Yes – Note 2	Yes	n/a	Yes – Note 2	Yes	n/a

Note 1 – If job has on track equipment then these qualifications are required.

Note 2 – If these employees operate the vehicles and/or equipment on track.

Note 3 – If these employees are used to be climbing signal and communication structures.

TWSIs = Track Worker Safety Instructions

14.0 Handling Switches

14.1 When hand throw or dual control switches are to be handled by more than one CROR qualified employee, peer to peer communication must take place. The employee handling the switch must communicate the following via radio to the foreman:

- Location of the switch and it's number, if applicable.
- Their name.
- The route the switch is lined for.
- Who, if needed, will line the switch back to its required position.
- Confirmation when dual control switches are back on power and locked.

14.2 Power switch cranking within the USRC shall follow the "Switch Cranking Procedures" as established by the Toronto Terminal Railway and approved by Metrolinx.

15.0 Highway/Roadway Grade Crossings and Traversing a Highway/Roadway Grade Crossing

15.1 Hi-Rail Vehicles at Highway/Roadway Grade Crossings

When hi-rail vehicles are being removed from or placed on the track, at/or near a grade crossing, employees must warn the traveling public by:

- a) Displaying 360 degree flashing light and four way emergency flashers, (if equipped).
- b) Employees must watch for highway vehicles and provide flagging if conditions require such an action.
- c) When road traffic volume warrants, road traffic must be stopped before attempting to mount or dismount the track with the hi-rail vehicle. This can be accomplished by:
 - i. Stopping traffic in each direction and requesting the motorist to hold his position until the hi-rail is clear of the crossing, or
 - ii. Where equipped, activating the automatic warning system.

15.2 Any track unit or hi-rail must be operated with caution when approaching highway/roadway grade crossings. This includes giving roadway traffic preference and:

- a. Approaching grade crossing under complete control, being prepared to stop if necessary.
- b. A track unit must not obstruct a highway/roadway grade crossing until the way is seen to be clear by the operator of the track unit.
- c. A track unit must be brought to a full stop before proceeding over a highway/roadway grade crossing when the view of the approach is obstructed or when traffic is heavy.
- d. If required due to traffic volumes, sightlines, or other special conditions, the operator of the track unit must only proceed over the highway/roadway grade crossing after stopping under the protection of a flag-person, except a track unit being operated by one

person alone may after stopping,
proceed with extreme caution.

- 15.3 At all road crossings, the operator of a track unit must be prepared to stop clear of the crossing. When a conflict with approaching highway traffic exists the track unit must be brought to a stop and may only proceed when traffic has cleared or stopped and it is safe to do so.
- 15.4 Where the view is obstructed, or road traffic is heavy or travels at high speeds, a track unit must be brought to a full stop, clear of the crossing. Once it is safe, the track unit may then proceed.
- 15.5 Highway traffic must be given the right-of-way unless protection is provided by one of the methods in 15.6, 15.7 or 15.8.
- 15.6 At crossings where a protective device exists that can be operated by a switch or remote control device, the protection may be activated to protect movements through the crossing. The crossing may be occupied once roadway traffic has come to a stop. Once the track unit has cleared the crossing, the protective device must be returned to normal.
- 15.7 At crossings protected by a flag person (Traffic Control Person), the track unit may proceed when given the appropriate signal by the flag person (Traffic Control Person).
- 15.8 When necessary, the occupants of a track unit will protect against roadway traffic. Procedures specified in sections 16 through 21, "Manual Protection at Highway/Roadway Grade Crossings" shall apply.

Manual Protection at Highway/Roadway Grade Crossings

16.0 Scope

- 16.1 These practices are intended to ensure that there are acceptable procedures and instructions in place to permit railway employees to safely perform manual protection at highway/railway grade crossings when:
 - a. The uncontrolled movement of traffic could be hazardous to workers;
 - b. Work is being performed at or near a railway/road grade crossings;
 - c. Automatic warning devices are not working as intended; or
 - d. Signal light, gates, and other protective devices are broken or damaged.
- 16.2 Except as otherwise noted, this document is intended to apply to manual protection performed by contractors working on behalf of Metrolinx or other authorized and qualified persons.

17.0 General Principles

- 17.1 Manual protection of highway/railway grade crossings should be carried out in a manner that provides roadway users with a message consistent to that which they encounter for other roadway flagging situations.
- 17.2 Clear instructions must be in place between railway and highway flag-persons when both are involved in a manual protection plan.
- 17.3 Vehicles should not be left in a location that could interfere with the view of grade crossing warning systems or flag-persons.
- 17.4 Unnecessary prolonged activation of railway crossing warning systems should be avoided.

18.0 Definitions

- 18.1 **Flag-person** means a responsible employee or contractor qualified by the railway company or the road authority to stop or otherwise direct and control highway traffic through a highway/roadway grade crossing through instruction and a demonstrated knowledge of this

document and all other applicable rules, procedures and instructions.

- 18.2 **Foreman** means the designated employee in charge of work at the grade crossing.
- 18.3 **Highway/Roadway Grade Crossing** means a location where a public highway, road, street, or unrestricted private roadway and associated sidewalks and any pedestrian or bicycle pathway cross one or more railway tracks at grade.
- 18.4 **Qualified person** means a person, who, because their knowledge, training and experience is qualified to perform that duty safely and properly.
- 18.5 **Railway Company** means a railway company that owns or operates over the line of railway at the grade crossing.
- 18.6 **Road Authority** means the public agency that has legal authority to open and maintain a road that passes across the line of railway at the grade crossing.
- 18.7 **Traffic** means all road users including drivers, cyclists and pedestrians that may use a grade crossing.
- 18.8 **Traffic control** means a method used for warning traffic and protecting track work at or near grade crossings.
- 18.9 **Traffic control plan** means the plans or written procedures detailing the traffic accommodation activities for a grade crossing project. Traffic control plans must be approved by the proper road authority.

19.0 Protection Required

- 19.1 Malfunction of Automatic Warning Systems
 - a. When a railway company is aware that an automatic grade crossing warning system malfunction has taken place, a qualified person shall arrange for appropriate means of warning highway traffic and railway employees. This may include but is not limited to:
 - i. Train and engine crews providing manual protection until the train or engine movement fully occupies the crossing;

- ii. A qualified flag-person providing manual protection in accordance with Section 19, until the on-track equipment has cleared the crossing;
 - iii. A uniformed police officer providing manual protection in accordance with practices acceptable to their organization until the on-track equipment has cleared the crossing; and
 - iv. In the case of workers at or near the crossing, a lookout to warn workers of approaching traffic.
- b. A malfunction of a warning system at or near a grade crossing includes:
 - i. An activation failure, a partial activation or a false activation of an automatic warning system or any of its components;
 - ii. When traffic signal pre-emption systems, designed to operate in conjunction with the automatic warning system at or near a grade crossing, will not operate or will not operate properly. In this case, the road authority must be notified immediately.
- c. Movement of trains where there is known to be a malfunction of an automatic warning system shall be governed in accordance with current company operating instructions and Canadian Rail Operating Rules.

19.2 Traffic Control for Very Short Duration Work

In instances where maintenance work at a grade crossing may be of very short duration and will have a minimal impact on traffic, a qualified person at the location must review the activity and assess the need for traffic control measures. Depending on the work to be performed, control measures could include items such as a lookout to warn workers of approaching traffic,

flag persons and/or advance warning signage.

- a. Examples of such activities would include but not be limited to:
 - i. Removal of snow and ice build-up in flange ways;
 - ii. Repair of high spikes;
 - iii. Visual ground inspection of track and signal equipment;
 - iv. Testing the operation of a grade crossing warning system;
 - v. Removal of isolated debris from crossing surface; or
 - vi. When required, parking a vehicle on the shoulder of the road or the right-of-way in the immediate vicinity of grade crossing.
- b. All workers must wear high-visibility reflective apparel and any work vehicles in the vicinity must employ 360 degree flashing lights and 4-way emergency flashers.
- c. In all cases the railway company shall safely restore normal operations of the system as soon as possible.

19.3 Traffic Control for Scheduled Work in the Vicinity of a Grade Crossing

When carrying out scheduled work in the vicinity of a highway/railway grade crossing, except as provided in Sections 19.1 and 19.2 above, a sufficient number of flag-persons or other means of manual or positive protection, must be provided when:

- a. Work is to be carried out on a line of the railway that may cause obstruction of sight-lines at a highway/roadway grade crossing not equipped with an automatic warning system when there is the possibility of the operation of a train.
- b. The crossing warning system which includes either the warning lights with or without gates, advance warning system, or interconnected traffic signals or prepare to stop signs are unable to operate properly due to scheduled maintenance or construction work within the rail

approach to the crossing or the road approach to the crossing when there is the possibility of the operation of a train.

- c. Work equipment is close enough to the crossing to obstruct the motorist view of approaching trains or is continuously activating the warning system.
- d. Test of a highway/roadway grade crossing warning system causes the operation of the light units or gate arms at the same time that a train or other railway equipment may enter onto the operating control circuits of the warning system.
- e. Traffic is required to pass a worker, equipment or other obstruction that may block all or part of the traveled roadway, except as outlined in Section 18.2 above (Very Short Duration Work).
- f. Train movements are anticipated and the presence of track units or work equipment could lead to confusion for highway users.

Should the work affect the highway/roadway grade crossing for an extended period of time or result in roadway lane closures, the road authority must be notified in advance as provided for in Section 18.4.

19.4 Traffic Control for Lane Closures and Long Duration Construction Work

Before undertaking work which will require the regulation of traffic over a grade crossing for an extended period of time or which will require lane closures, the road authority must be notified well in advance and:

- a. A written traffic control plan must be prepared (see Figure 2);
- b. A flag-person or other mutually agreed to means of manual protection in accordance with the traffic control plan must be provided;
- c. The foreman or other person in charge of the work must:
 - i. Be governed by instructions from the road authority ensuring the flagging

protection procedures to be followed for such work conforms to the applicable provincial or road authority requirements;

- ii. Ensure that all protective devices as determined above are in place prior to commencement of work;
- iii. Determine who will perform the flagging duties, whether the road authority, railway personnel or a contractor;
- iv. Ensure detailed instructions and job briefings are provided to persons performing traffic control duties; and
- v. Notify Signals and Communications of work to be done at the crossing and arrange for the Signal Maintainer or other authorized and qualified person to isolate/deactivate/reactivate automatic warning devices, if applicable.

20.0 Equipment Required

- 20.1 For daytime grade crossing work requiring manual protection, each flag-person shall be provided with:
 - a. A traffic control hand held approved STOP/SLOW paddle as shown in Figure 2 is recommended. In an emergency situation a red flag may be used when a STOP/SLOW paddle is not available;
 - b. Approved high visibility reflective vest or similar apparel;
 - c. Required personal protective equipment;
 - d. An effective means of communication when flag-persons are not visible to each other.
- 20.2 A flag-person used for scheduled or construction work must have the following clothing and equipment:
 - a. A STOP/SLOW sign as shown in Figure 2, mounted on a 4 foot long pole;

- b. Approved high visibility reflective vest or similar apparel;
- c. Required personal protective equipment;
- d. An effective means of communication when flag-persons are not visible to each other;
- e. The appropriate traffic cones, barricades, signs, lighting and other traffic control devices prescribed by the province of Ontario.

These requirements may be altered or augmented as necessary to meet the requirements prescribed by the province and the traffic control plan.

- 20.3 During the hours of darkness, or in other conditions of poor visibility, in addition to the above equipment requirements, each flag-person is to be provided with a working flashlight which may be fitted with a red signalling baton, or if all batteries are exhausted, a lit red fusee.

21.0 Flagging Procedures

21.1 General Procedures

- a. During traffic control each flag-person must remain on duty at the assigned station until relieved.
- b. Except as provided by section 20.4, a flag-person must not direct traffic for more than one lane at the same time.
- c. A flag-person shall not perform any other work while physically directing vehicular traffic.
- d. A flag-person must stand in a safe position on the side of the lane he/she is flagging with an unobstructed view of approaching traffic.
- e. A flag person must ensure that it is safe for a movement to proceed before signalling for that movement to proceed.
- f. No employee other than the flag-person may give signals to a motorist except in an emergency.
- g. Only one flag-person may give a signal to a motorist at one time.
- h. A flag-person must make all motions and signals for traffic control precisely and deliberately so that the meaning of signals is clearly understood.

21.2 Hand Signals

- (A) When using a STOP/SLOW paddle a flag-person must:
 - i. Use the normal signals shown in Figure 4 when stationed on the driver's right side of the traffic lane under the flag-person's control.
 - ii. The signals shown in Figure 4 will be reversed when the flag-person is stationed on the drivers left side.
 - iii. The flag-persons sign must not be used to wave traffic on and must never be displayed to traffic in other than a static manner.
- (B) When using a red flag, a flag-person must use the following procedures:

- i. To stop traffic; face traffic and extend the flag staff horizontally across the traffic lane in a stationary position so that the full area of the flag is visibly hanging below the staff. The free arm shall be held with the palm of the hand above the shoulder level toward approaching traffic.
- ii. To direct traffic to proceed; stand parallel to the traffic movement and with flag and arm lowered from the view of the road users, motion with the free hand for road users to proceed. Flags shall not be used to signal traffic to proceed.
- iii. To alert or slow traffic; face traffic and slowly wave the flag in a sweeping motion of the extended arm from shoulder level to straight down without raising the arm above a horizontal position. The flag-person shall keep the free hand down.

21.3 Emergency Vehicles

Emergency vehicles such as fire trucks, police vehicles, and ambulances pose special problems for flag-persons and emergency procedures to be used should be known prior to commencement of flagging operations.

- a. When the flag-person becomes aware that an emergency vehicle is approaching, he or she should immediately contact the other flag-persons in order to open a path for the emergency vehicle(s).
- b. If there is a hazard that will affect the safety of an emergency vehicle, yourself or others, the emergency vehicles must be stopped, even ever so briefly, in order to relay specific instructions.

21.4 Traffic Control with one Person

Whenever one person is required to flag at crossings where vehicles can move in either direction or more than one lane is involved, the flag-person should:

- a. Speak to the driver of the first vehicle stopped to ensure that he/she remains stopped clear of the crossing while the flag-person stops vehicles arriving from the other direction, or from an adjoining lane.
- b. When stopping vehicles at a crossing with more than one track, the flag-person should first stop the vehicle whose line of site is most restricted.

21.5 Traffic Control Signs

- a. When traffic control is scheduled or of long duration, signs advising of a flag-person ahead should be placed in advance of each flag-person's station. (Examples shown in Figure 3).
- b. Signs must be erected as per instructions from the road authority.
- c. Signs must be checked to ensure they are functioning as intended.
- d. Signs must be removed promptly upon completion of work.

21.6 Scheduled and Construction Work Requiring Traffic Control Plans

- a. A detailed traffic control plan must be written and approved by the road authority.
- b. These plans should include communication procedures, job briefings and situational awareness.
- c. Detailed instructions must be given to the flag-person(s) along with job briefings.
- d. Unless otherwise identified in the traffic control plan, grade crossing protection shall be in conformity with the requirements of the Manual of Uniform Traffic Control Devices for Canada (MUTCD).
- e. Road closures and barriers should be considered whenever work at a grade crossing is being planned. Barricades must only be placed as per the road authority's instructions.

21.7 Notification of the Signal Maintainer or Other Authorized Personnel

Scheduled track work must not be performed within the limits of an automatic warning system at a grade crossing until the signal maintainer or other authorized and qualified person has been notified. Only Signals and Communications personnel may isolate/deactivate/reactivate automatic warning systems at grade crossings.

Figure 2 STOP/SLOW Sign

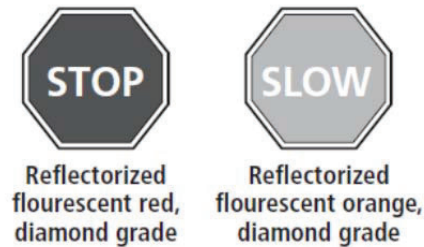

The STOP/SLOW paddle shall have an octagonal shape on a rigid handle. STOP/SLOW paddles shall be at least 450 mm (18 in) wide with letters at least 150 mm (6 in) high. The background of the STOP face shall be red with white letters and border. The background of the SLOW face shall be orange with black letters and border. When used at night the STOP/SLOW paddle shall be reflectORIZED.

NOTE: All traffic control equipment, including signs and personal protective equipment must be kept clean and in working condition.

Figure 3 Traffic Control Plan

Diagram shows an example of a traffic control plan for protecting work at a grade crossing. (two way traffic, single lane closure)

NOTE: This is an example only. Signs should be placed as per traffic control plan developed with the proper road authority.

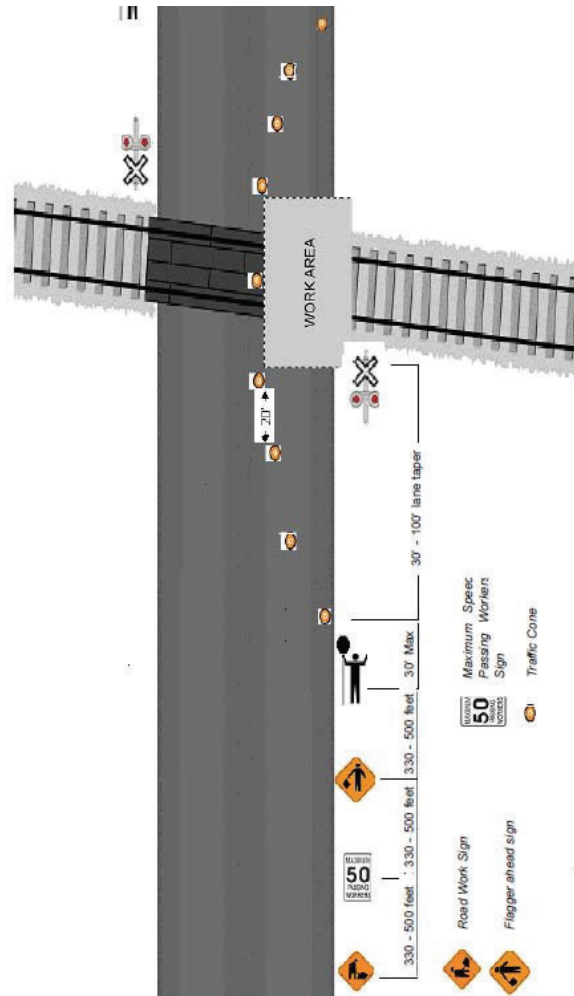

Each situation will require individual safety assessment, and consideration must be given to traffic volume, vehicle types, sightlines and distances, sign spacing, duration of work and other factors to ensure traffic control devices are adequate in each case.

1. All signs shall be spaced 330-500 feet (100-150 meters) apart unless otherwise indicated.
2. All signs shall be kept clean and in good condition.
3. Identical signing is required from both directions.
4. The bottom of sign should not be less than 1' (30 cm) above the road surface.
5. All signs must be in accordance with instructions from road authority.
6. Traffic cones are placed at 20 foot (6 meter) maximum intervals when flag-persons are used.
7. Lane taper must not exceed 100' (30 meters) or be less than 30' (10 meters) when flag-persons are used.
8. No vehicles shall be parked on road unless required for actual operations.
9. Traffic Control plan must document procedures to follow to accommodate emergency vehicles. Flag-persons must discuss and understand these procedures prior to commencement of flagging operations.

Figure 4 Hand Signals when STOP/SLOW paddle is used for traffic control

To Stop Traffic



(A) By day

- Face traffic.
- Display "STOP" paddle in right hand.
- When approaching vehicle has almost stopped, use left arm to indicate stopping point.



(B) By night

- Face traffic.
- Display static reflectorized "STOP" paddle in right hand and flashlight with red signaling baton attached in left hand.
- Move left arm from 3 to 6 o'clock.
- When approaching vehicle has almost stopped, use flashlight/baton to indicate stopping point.

To Slow Traffic



(A) By day

- Face traffic.
- Display static "SLOW" paddle in right hand.
- If traffic slows below desired speed give appropriate "Move Traffic" signal.



(B) By night

- Face traffic.
- Display static reflectorized "SLOW" paddle in right hand and flashlight with red signaling baton attached in left hand.
- Move left arm from 3 to 6 o'clock.
- If traffic slows below desired speed give appropriate "Move Traffic" signal.

To Move Traffic Slowly

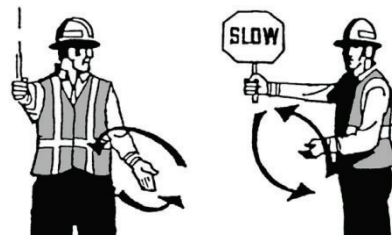

(A) Slowly by day

- Face across the approach lane and look across left shoulder at traffic to be moved.
- Display static "SLOW" paddle in right hand.
- Advance traffic by rotating lower left arm in an elliptical manner in the direction the vehicle wheels will rotate.

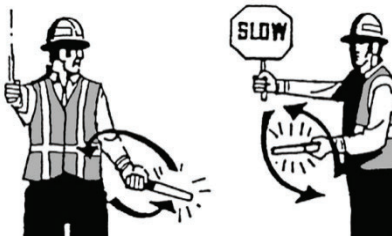

(B) Slowly by night

- Face across the approach lane and look across left shoulder at traffic to be moved.

- Display static “SLOW” paddle in right hand and flashlight, with red signaling baton in left hand.
- Advance traffic by rotating lower left arm.

To Move Traffic at posted speed

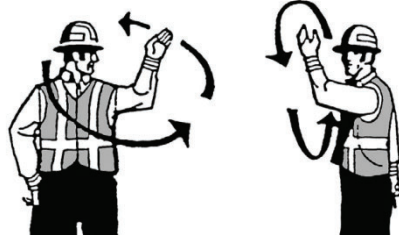

(A) At posted speed by day

- Face across the approach lane and look across left shoulder at traffic to be moved.
- Lower right arm to conceal paddle and motion traffic on.

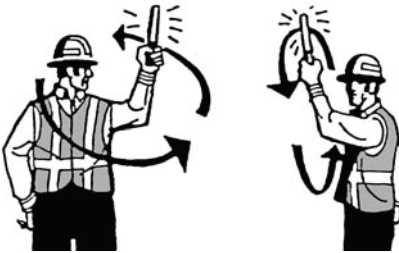

(B) At posted speed by night

- Face across the approach lane and look across left shoulder at traffic to be moved.
- Hold flashlight with red signaling baton in left hand.
- Lower right arm to conceal paddle and motion traffic on with left arm at shoulder level.